



March 2025

# PRODUCT GUIDE



Level 5/ 3 Te Kehu Way, Sylvia Park,  
Mt wellington Auckland 1060



02 2427 9322



[www.dynamitepromotions.co.nz](http://www.dynamitepromotions.co.nz)



[info@dynamitepromotions.co.nz](mailto:info@dynamitepromotions.co.nz)



Aluminium Composite Panel (Dibond) Signs .....	16
Arch Banners.....	2
Backlit Poster Frames .....	7
Backpack Tear Drop & Wing Banners.....	2
Bollard and Light Pole Covers (Corflute) .....	16
Brochure Holders .....	19
Bunting .....	13
Cafe Barriers .....	8
Cafe Umbrellas (for events) .....	8
Camping Canopies.....	13
Car Flags .....	9
Corflute Signs .....	16
Exhibition Booths .....	21
Exhibition Tables .....	17
Flag Pole Flags .....	9
Floor Stickers .....	15
Footpath Signs .....	8
Hand Wave Flags .....	9
Inflatables .....	23
Light Boxes .....	20
Light Box Counters .....	21
Marquees .....	12
Media Walls .....	15
Mesh Polyester Banners .....	7
Music Stand Covers .....	10
Paper Products .....	24
Pennants .....	11
Plastic and Timber Cards & Accessories .....	25
Pole Wraps .....	11
Polyester Sleeve Floor Displays .....	17
Pop Up Banners .....	14
Projector Signage .....	11
Pull Out Banners .....	10
Pull Up Banners (Light Weight and Premium) .....	5
Run Through Banners .....	14
Sashes .....	10
Shop Front Flags .....	10
Snap Lock Picture Frames .....	7
Stage Skirts .....	15
Stretch Fabric Displays .....	18
Stretch Fabric Displays - Shelving .....	19
Table Covers .....	22
Table Top Banners .....	6
Tear Drop and Wing Banner Bases / Accessories .....	4
Tear Drop and Wing Banner Information .....	2
Tear Drop and Wing Banner Shapes / Sizes .....	3
TIFO Banners .....	7
Vinyl Mesh and Vinyl Banners .....	11



## Tear Drop and Wing Banners

### Supplied with base of choice

- Free artwork set up
- Banner shapes and sizes are on page 3
- Banners are supplied with an Oxford carry case and base of choice
- Banner poles are fibreglass
- Eco-Friendly recycled polyester manufactured to Global Recycled Standard 4.0 (GRS 4.0) and printed with Eco-Friendly inks
- Banners are printed UV resistant full colour dye sublimation, banner sleeve pockets are black (or white if requested)
- Single sided banners are printed on 110gsm knitted polyester
- Double sided banners are printed on 2 pieces of 110gsm knitted polyester with a UV block-out sheet in-between to prevent the image on the other side of the banner showing through
- Replacement skins available
- Standard lead time 10 - 15 days from artwork approval for orders up to 19 banners. Please contact us for lead time for orders of 20 or more banners

## Arch Banners

## Backpack Tear Drop and Wing Banners

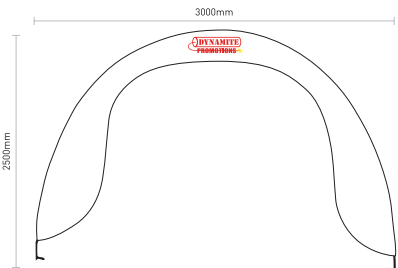

Supplied with backpack

- Banner shapes and sizes:
  - Tear Drop (665mm x 1310mm)
  - Wing Banner - all shapes (500mm x 1400mm)
- Pole fits our standard Tear Drop and Wing Banner Bases

# Tear Drop Banner

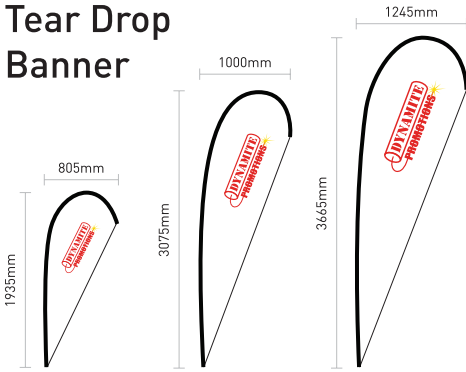

# Wing Banner Shape 1

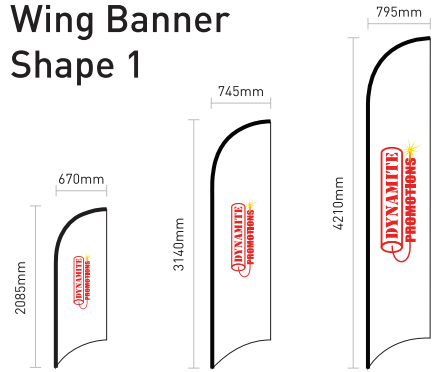

# Wing Banner Shape 2

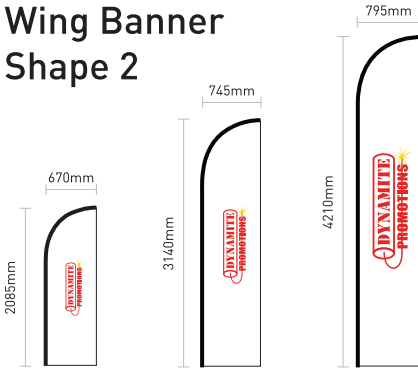

# Wing Banner Shape 3

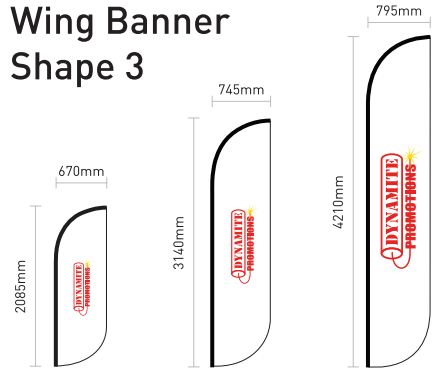

# Wing Banner Shape 4

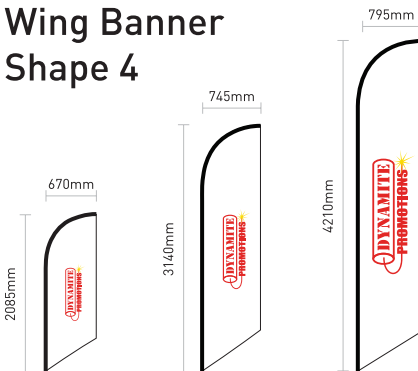

# Wing Banner Shape 5

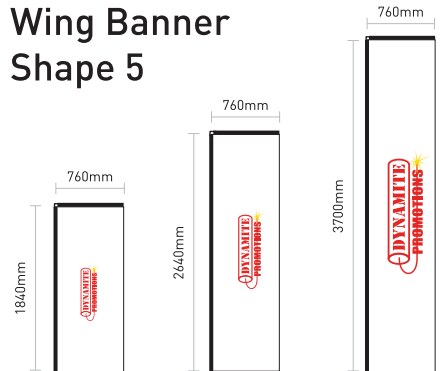

- Total set up height from ground dependent on pole size and base type
- Banners are supplied in an Oxford carry case and include pole kit and selected base type
- Banner sleeve pockets are black (or white if requested).



# Bases / Accessories



Water Bag  
(optional extra)

## Retractable Cross Base

- Weight - 3kg
- Chrome plated
- Great for installing wing and tear drop banners indoors or outdoors with a water bag



## Water Base

- Weight - approx. 18kg when filled
- Available in black only
- Perfect for installing wing and tear drop banners in windy areas



## Car Base

- Weight - 3kg
- Suitable for installing banners next to a vehicle as the car wheel holds the base in place



## Screw In Base / Spiky Base

- Light weight
- Excellent for installing wing and tear drop banners on lawn or other soft surfaces
- Screw In Base can be left in ground permanently

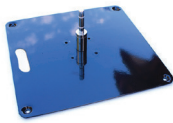

Water Bag  
(optional extra)

## Flat Metal Base

- Weight - 5kg
- Black powder coat with chrome spindle
- Great for installing wing and tear drop banners indoors or outdoors with a water bag



## Wall / Ground Mount Brackets

- Allows the banner to be installed off of the ground for increased height and visibility
- Available in 25 and 180 degree and ground mount bracket
- For use with SMALL and MEDIUM banners only

Water Bag  
(optional extra)



- Great for use with flat metal base or cross base in windy areas



## Marquee Water Base

- Weight - approx. 9kg when filled

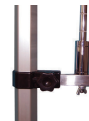

## Bracket for Wing / Tear Drop Banner



## Umbrella Water Base

- Weighs approx. 23kgs when filled



## Sand Bag



## Gutter Kit

- Required when joining 2 marquees

Diameter of spindle on all bases is 15mm

# Pull Up Banners

- Free artwork set up
- Ideal for trade shows, showrooms, reception areas, displays, conferences, presentations etc.
- Quick set up and compact storage
- Light Weight and Premium Pull Up Banner base options available
- Full colour single sided digital print
- Size options:
  - 850mm x 2020mm (single sided Light Weight or Premium)
  - 1000mm x 2020mm (single sided Light Weight or Premium)
  - 1200mm x 2020mm (single sided Premium)
- Supplied with padded carry bag
- Please contact us for lead times



Light Weight Pull Up Banner



Premium Pull Up Banner

## Table Top Pull up Banners

- Free artwork set up
- MOQ of 10 applies
- Ideal for trade shows, presentations, displays, conferences, etc.
- Silver aluminium light weight base available in A3 & A4
- Full colour single or double sided digital print on curl resistant media
- Standard lead time for quantities up to 19 is 5 - 7 days from artwork approval. Please contact us for lead time for orders of 20 or more banners



## Table Top Tear Drop Banners

- Free artwork set up
- MOQ of 10 applies
- Full colour dye sublimation print on 110gsm knitted polyester
- 580mm tall, weight 0.3kg
- Single sided only (reverse image on back)
- Print can be different on each banner eg. different numbers for table settings
- Supplied with fibreglass pole and metal base
- Replacement skins available
- Standard lead time 10 - 15 days from artwork approval



## Table Top Flags

- Free artwork set up
- Great for trade shows, presentations, displays, conferences, event table setting, etc.
- Full colour single sided print on polyester flag
- Print can be different on each banner eg. different numbers for table settings
- Plastic pole and base
- Standard size:
  - Flag - 210mm x 140mm
  - Pole - 270mm
  - Custom sizes available
- Standard lead time 10-15 days from artwork approval



# TIFO Banners

- Free artwork set up
- Great for supporting teams at major sports events
- Available in custom shapes and sizes
- Full colour dye sublimation print
- 130gsm polyester (flame resistant polyester fabric available)
- Supplied with reinforced hemmed edges
- Standard lead time 10 - 15 days from artwork approval

ANY SIZE  
BANNER  
AVAILABLE



# Mesh Polyester Banners

- Free artwork set up
- Eco-Friendly recycled material manufactured to Global Recycled Standard 4.0 (GRS 4.0) and printed with Eco-Friendly inks
- Full colour dye sublimation digital print
- 130gsm polyester mesh fabric
- Banners are supplied with reinforced edges and eyelets every 1000mm
- Standard lead time 10 - 15 days from artwork approval



# Snap Lock Picture Frames

- Free artwork set up
- MOQ of 10 applies
- Size options:
  - A4 print size
  - A3 print size
- 25mm rounded snap lock frame
- Supplied with full colour digital print
- Standard lead time for quantities up to 14 is 5 - 7 days from artwork approval. Please contact us for lead time for orders of 15 or more



# Backlit Poster Frames



- Free artwork set up
- Great for trade shows, presentations, displays, shop windows, shopping malls etc.
- Full colour digital print on 200gsm backlit film
- Portrait or landscape orientation options
- Detachable and adjustable legs
- Acrylic front - clear
- Light weight unit, 10mm thick
- Size options:
  - A4 (0.6kg)
  - A3 (1.0kg)
- Supplied with transformer
- Standard lead time 3 - 5 days from artwork approval

# Footpath Signs

- Free artwork set up
- Great for advertising outdoors in front of businesses and on footpaths
- Plastic water base weighs 13kg when filled
- 4mm Aluminium Composite Panel sign board with handle
- Size: 600mm x 800mm
- Single or double sided SAV print (whiteboard laminate can be added for ease of changing message)
- Please contact us for lead times



# Café Barriers

- Free artwork set up
- Great for use in café/restaurant alfresco areas or for other barrier uses
- Frame is supplied flat packed and is simple to assemble
- Light weight aluminium tube frame with feet (43mm diameter frame)
- Full colour double sided dye sublimation print on 230gsm polyester
- Size options:
  - 1040mm x 915mm (graphic area 900mm x 710mm, plus 65mm black outer sleeve)
  - 2040mm x 915mm (graphic area 1900mm x 710mm, plus 65mm black outer sleeve)
- Replacement skins available
- Standard lead time 10 – 15 days from artwork approval

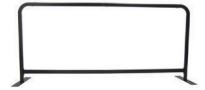

# Café Umbrellas (for events)

- Free artwork set up
- Umbrella supplied with aluminium frame (47mm diameter pole) and printed canopy
- Eco-Friendly recycled material manufactured to Global Recycled Standard 4.0 (GRS 4.0) and printed with Eco-Friendly inks
- Canopy is 500D Oxford fabric which is waterproof, PU coated and flame retardant
- 2m x 2m square canopy available with or without a valance
- Full colour dye sublimation print \*
- Standard lead time 10 – 15 days from artwork approval



*\*Suitable for event use - if exposed to the weather permanently, fading will occur. Replacement canopies are available.*

# Flag Pole Flags

- Free artwork set up
- Flags include sister clips for easy installation - other fittings available (pole not included)
- Eco-Friendly recycled material manufactured to Global Recycled Standard 4.0 (GRS 4.0) and printed with Eco-Friendly inks
- Flags are dye sublimated on 110gsm knitted polyester (approx. 90% bleed through) or 130gsm trilobal polyester (approx. 75% bleed through) with double stitched edges
- Standard sizes:
  - 1800mm x 900mm
  - 2500mm x 1250mm
  - Custom sizes available
- 600D woven polyester available for extra durability and longer life
- Standard lead time 10 - 15 days from artwork approval for orders up to 49 flags. Please contact us for lead time for orders of 50 or more flags

CUSTOM SIZES AVAILABLE



Sister Clip

# Hand Wave Flags

- Free artwork set up
- Standard flag size:
  - 300mm x 200mm
  - Custom sizes available
- Available in:
  - PVC: Double sided print on 0.2mm PVC
  - Polyester: Single sided print (100D polyester with approx. 85% bleed through)
  - Paper: Single or double sided print on coated paper
  - PPE Clear Plastic: Single sided print (with bleed through)
- Supplied with plastic pole
- Please contact us for lead times

CUSTOM SIZES AVAILABLE



# Car Flags

- Free artwork set up
- Flag size is 450mm x 300mm
- Full colour single sided digital print on 110gsm knitted polyester
- Supplied with plastic pole and car window clip
- Please contact us for lead times



# Shop Front Flags

- Free artwork set up
- MOQ of 5 applies
- Full colour digital print on 400gsm double sided vinyl
- Flag size 400mm x 600mm
- Supplied with plastic pole and bracket
- Standard lead time 10 - 15 days from artwork approval



# Pull Out Banners

- Artwork set up fee applies
- MOQ applies
- Size of opened banner is 700mm x 240mm
- Double sided or single sided print available
- Please contact us for lead times



# Music Stand Covers

- Free artwork set up
- Standard size:
  - 540mm wide x 530mm high, plus 200mm sleeve to slide over music stand
  - Custom sizes available
- Full colour digital print on 160gsm satin drill
- Standard lead time 10 - 15 days from artwork approval



# Sashes

- Free artwork set up
- Great for pageants, hen's nights, birthdays, baby showers, etc.
- Full colour digital print on satin polyester
- Supplied in poly bag with safety pin
- Standard size:
  - 1800mm x 100mm
  - Custom sizes available
- Standard lead time 10-15 days from artwork approval



# Pennants

- Free artwork set up
- Standard size:
  - 210mm x 300mm with 20mm tassels
  - Custom sizes available
- Full colour digital print on 160gsm satin drill
- Includes 360mm cord 235mm wide pole
- Standard lead time 10 – 15 days from artwork approval



# Vinyl Mesh and Vinyl Banners

- Free artwork set up
- Full colour CMYK digital print
- Single sided and double sided vinyl banners printed on outdoor quality vinyl (single sided only for vinyl mesh)
- Banners are supplied with welded edges and eyelets every 1000mm
- Please contact us for lead times

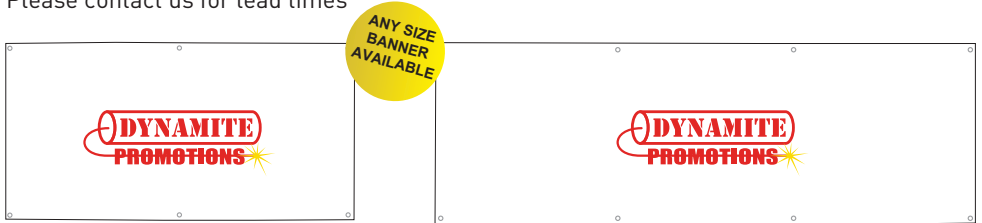

# Pole Wraps

- Free artwork set up
- Full colour print on vinyl with Velcro joiner
- Custom sizes available
- Please contact us for lead times



# Projector Signage

- Free artwork set up
- Options for indoor and outdoor use
- Aluminium alloy body and LED light
- Single or rotating logo options available
- Please contact us for lead times



# Marquees

- Free artwork set up
- Supplied with 40mm aluminium frame, printed canopy, ropes, pegs and wheel bag
- Canopy is 500D Oxford fabric which is waterproof, PU coated and flame retardant
- Canopies and walls available in Eco-Friendly recycled material manufactured to Global Recycled Standard 4.0 (GRS 4.0) and printed with Eco-Friendly inks
- Single sided or double sided full walls available for all sizes (half walls available for 3 metre sides only)
- Single sided walls available with window
- Clear protective screen walls available for 3 metre sides
- Full colour dye sublimation print\*
- Size options:
  - 3m x 3m
  - 6m x 3m
- Replacement ropes and pegs available
- Frames and printed or unprinted walls and canopies available individually\*
- Please contact us for lead times

## Marquee Extras

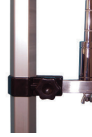

**Bracket for Wing / Tear Drop Banner**



**Gutter Kit**  
Gutter kit required when joining 2 marquees



**Sand Bag**



**Marquee Water Base**  
Weight - approx. 9kg when filled

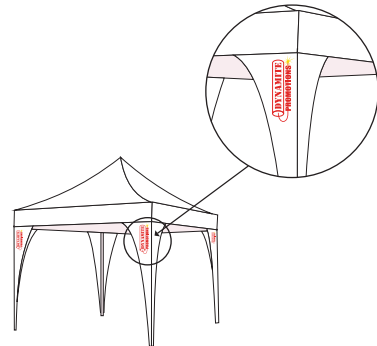
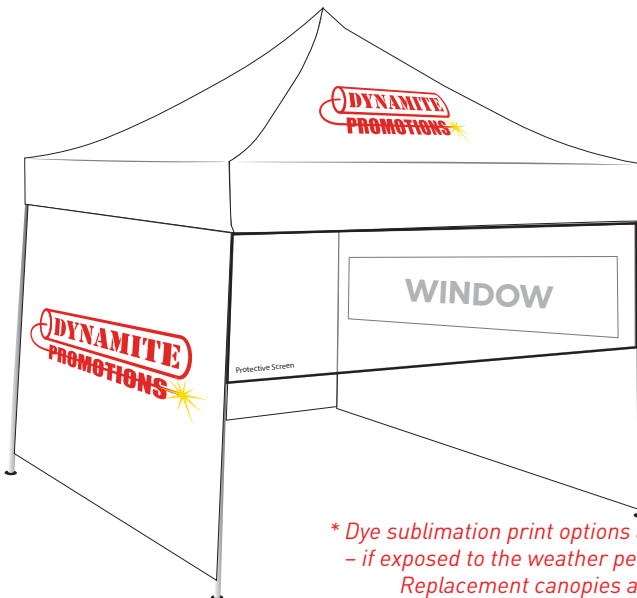

**Marquee Leg Covers**

\*Un-printed stock walls and canopies available in black, red, blue, yellow, green, and white.

*\* Dye sublimation print options are suitable for event use only  
- if exposed to the weather permanently, fading will occur.  
Replacement canopies and walls are available*

# Camping Canopies



*\*Suitable for event use - if exposed to the weather permanently, fading will occur. Replacement canopies are available.*

- Free artwork set up
- Full colour dye sublimation single sided print\*
- Supplied with 33mm aluminium poles (2400mm high), printed canopy, ropes and pegs.
- Canopy is 500D Oxford fabric which is waterproof, PU coated and flame retardant
- Replacement canopies, ropes and pegs available
- Size & shape options:
  - 4.5m x 4.5m (available in 4 or 6 angle shape)
  - 5.4m x 5.1m (available in 8 angle shape)
- Please contact us for lead times

# Bunting

- Free artwork set up
- Vinyl or polyester - single sided or double sided
- Recycled polyester and block-out available
- 30 flags per 10 metres as a standard - customisation available
- Standard sizes:
  - Triangle flags, 150mm x 200mm
  - Rectangle flags, 150mm x 200mm
  - Custom sizes available
- PVC also available - minimum order 2000 metres
- Please contact us for lead times

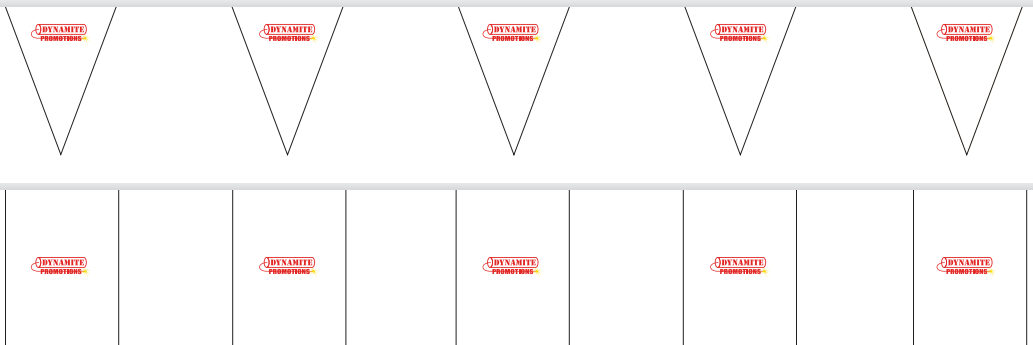
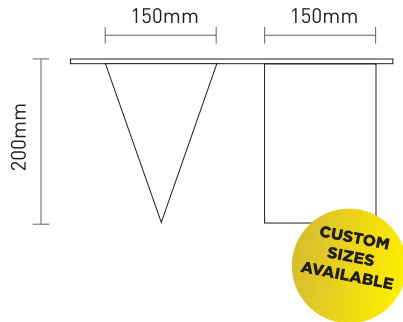

# Pop Up Banners

- Free artwork set up
- Eco-Friendly recycled material manufactured to Global Recycled Standard 4.0 (GRS 4.0) and printed with Eco-Friendly inks
- Full colour dye sublimation print on 250gsm knitted polyester
- All sides can be printed
- Supplied with steel wire frame and carry case
- Standard lead time 10 - 15 days from artwork approval for orders up to 24 banners. Please contact us for lead time for orders of 25 or more banners



## Round Pop Up Banners

- Size options:
  - 1200mm diameter
  - 1400mm diameter



## Horizontal Pop Up Banners

- Size options:
  - 1300mm x 660mm
  - 1600mm x 650mm
  - 2000mm x 1000mm



## Vertical Pop Up Banners

- Size options:
  - 920mm x 1100mm
  - 1050mm x 1250mm



## Three Sided Vertical Pop Up Banners

- Size option:
  - 920mm x 1100mm

Target hole can be included

# Run Through Banners

- Free artwork set up
- Great for sporting events
- Fabric banner skin means the banner can be re-used
- Full colour single sided dye sublimation print
- Arch Run Through banner:
  - 110gsm polyester
  - Eco-Friendly recycled material manufactured to Global Recycled Standard 4.0 (GRS 4.0) and printed with Eco-Friendly inks
  - Supplied with poles and spiky bases
  - Size: 3600mm x 2050mm
- Rectangle Run Through banner:
  - Available in Eco-Friendly recycled material manufactured to Global Recycled Standard 4.0 (GRS 4.0) and printed with Eco-Friendly inks
  - 250gsm polyester
  - Supplied with pole pockets each side (poles not included)
  - Size: 4000mm x 2500mm
  - Custom sizes available

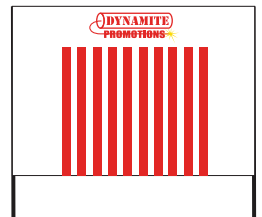

Standard lead time 10 - 15 days from artwork approval

# Floor Stickers

- Free artwork set up
- MOQ applies
- Floor stickers are a perfect advertising medium for floors, walls and footpaths
- Premium quality, offering long durability due to the composition of PVC and fabric
- Embossed textured matte finish to prevent slippage - R11 slip rating (Slip Resistance Test AS 4586:2031)
- Lifespan of the stickers is dependent on the movement at the place of installation, however, is estimated to be approximately 9 to 12 months in normal operation
- Full colour digital print and cut to custom sizes
- Stickers can be removed without leaving residue behind
- Standard lead time 5 – 7 days from artwork approval

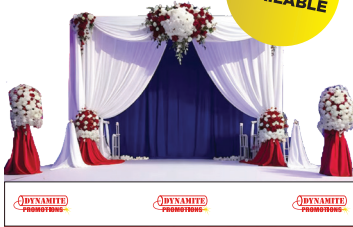

## Stage Skirts

- Free artwork set up
- Great for advertising at conferences, presentations, stage shows etc. and also hides the stage structure
- Available in Eco-Friendly recycled material manufactured to Global Recycled Standard 4.0 (GRS 4.0) and printed with Eco-Friendly inks
- Dye sublimation print on high quality 250gsm knitted polyester
- Includes Velcro or eyelets to attach to structure
- Custom sizes available
- Standard lead time 10 – 15 days from artwork approval

## Media Walls

- Free artwork set up
- Great for trade shows, exhibitions, presentations, green screens, etc.
- Eco-Friendly recycled material manufactured to Global Recycled Standard 4.0 (GRS 4.0) and printed with Eco-Friendly inks
- Dye sublimation print on high quality 250gsm knitted polyester
- Wrap around printed sides available
- Graphics are attached to the aluminium concertina style frame with Velcro
- Size options:
  - 2250mm x 2250mm (flat or curved wall)
  - 3000mm x 2250mm (flat or curved wall)
- Set up and pull down in minutes
- Total weight of frame and print approx. 10kg
- Replacement skins available
- Supplied with carry bag
- Standard lead time 10 - 15 days from artwork approval

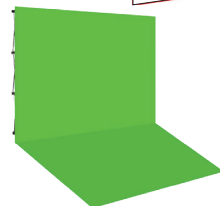

# Aluminium Composite Panels (Dibond)

- Free artwork set up
- Very durable - 4mm thickness
- Full colour digital print, single or double sided
- Suitable for indoor or outdoor use
- Custom sizes available
- Please contact us for lead times



# Corflute Signs

- Free artwork set up
- Great for signage, event advertising, novelty cheques, selfie frames etc.
- 3mm or 5mm thickness
- Full colour digital print, single or double sided
- Suitable for indoor or outdoor use
- Custom sizes available
- Please contact us for lead times



# Bollard & Light Pole Covers (Corflute)

- Free artwork set up
- Full colour digital print on SAV
- Size Options:
  - Bollard cover size 270mm x 1000mm x 3mm corflute
  - Light pole cover size 500mm x 1500mm x 3mm corflute
  - Custom sizes available
- Please contact us for lead times



# Polyester Sleeve Floor Displays

- Free artwork set up
- Great for trade shows, presentations, back drops etc.
- Light weight aluminium frame with plastic foldable feet (suitable for indoor use)
- Frame clicks together for quick and easy assembly and dismantle
- Full colour double sided polyester pillow case style sleeve slides over frame
- Size options:
  - 1000mm x 2300mm
  - 1200mm x 2300mm
- Replacement skins available
- Supplied with carry bag
- Standard lead time is 10 – 15 days from artwork approval

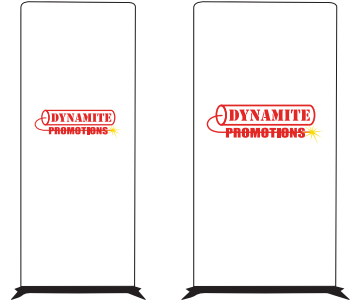

# Fabric Covered Tables

- Free artwork set up
- Great for trade shows, exhibitions, presentations etc.
- Entire table cover can be printed
- Dye sublimation print on 250gsm knitted stretch fabric
- Includes light weight frame
- Table size:
  - 800mm x 500mm (table top) x 1000mm (h), 10kg
- Graphic size:
  - 2200mm x 1020mm
- Weighs 9kgs / weight/load limit 20kgs
- Supplied with carry bag
- Standard lead time 10 – 15 days from artwork approval



# Fabric Covered Hydraulic Pop-Up Counters

- Free artwork set up
- Great for trade shows, exhibitions, presentations etc.
- Includes light weight frame
- Set up in less than 1 minute
- Entire table cover can be printed
- Dye sublimation print on 250gsm knitted stretch fabric
- Table size:
  - 700mm x 400mm (table top) x 1000mm (h), 10kg
- Graphic size:
  - 1510mm x 1000mm
- Weight/load limit 15kgs
- Standard lead time 10 – 15 days from artwork approval



# Stretch Fabric Displays

\* All stretch fabric displays supplied with carry bag

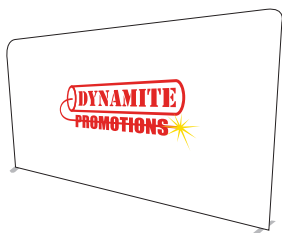

Straight shape

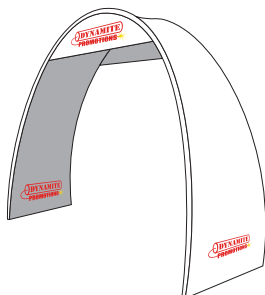

Curved Arch



H-shape (flat, angled or curved top)



H-wave shape

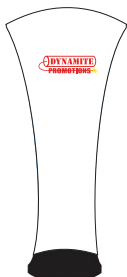

Curved Tower stand



Rectangular shape



Snake shape

- Free artwork set up
- Great for trade shows, presentations, displays, back drops etc.
- Light weight aluminium frame and feet (tube frame 1mm thick and 32mm diameter)
- Frame clicks together for quick and easy assembly and dismantle
- Eco-Friendly recycled material manufactured to Global Recycled Standard 4.0 (GRS 4.0) and printed with Eco-Friendly inks
- Full colour double sided dye sublimation print on 250gsm polyester sleeve (Snake shape and Hanging displays available as single sided print only)
- Size and shape options:
  - Straight shape (2950mm x 2210mm or 5940mm x 2210mm)
  - H-shape (flat, angled, curved top or wave 1000mm x 2500mm)
  - Snake shape (single sided print only 915mm x 2280mm)
  - Curved arch shape (2700mm x 1000mm x 600mm x 2300mm)
  - Rectangular shape (500mm x 700mm x 2000mm)
  - Curved Tower Stand (850mm x 2000mm)
- Replacement skins available
- Supplied with carry bag
- Standard lead time 10 – 15 days from artwork approval

# Stretch Fabric Displays - Hanging



Hanging Circle

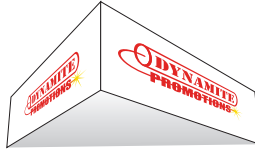

Hanging Triangle

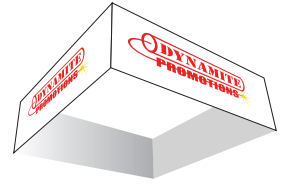

Hanging Square

- Size and shape options:
  - Hanging Circle (single sided print only 3048mm x 1219mm)
  - Hanging Triangle (single sided print only 3048mm x 1067mm)
  - Hanging Square (single sided print only 2438mm x 1067mm)

# Stretch Fabric Display - Table Top

- Eco-Friendly recycled materials manufactured to Global Recycle Standard 4.0 (GRS 4.0) and printed with Eco-Friendly inks
- Size and shape options:
  - 6 foot table top (1850mm x 1120mm)
  - 8 foot table top (2480mm x 1120mm)



# Stretch Fabric Display - Shelving

- Size - 710mm x 2246mm
- Up to 3 shelves
- Optional TV bracket in place of shelf

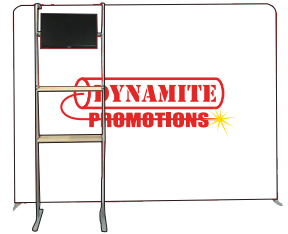

# Brochure Holders

- Great for trade shows, exhibitions, displays, malls etc.
- The 4-shelf rack comes flat packed in a strong nylon bag & unfolds in seconds
- Folds down to compact size for easy transportation
- Great to display brochures, flyers & catalogues in an organised manner
- Suitable for indoor use only
- Size - 275mm x 360mm x 1280mm
- Standard lead time 2 - 4 days from order



# Light Boxes

## Polyester Panel Insert Light Box

- Free artwork set up
- Great for trade shows, presentations, displays, shop windows, shopping malls etc.
- Easy to assemble light weight aluminium frame
- Full colour single sided or double sided dye sublimation print on 150gsm polyester
- Bright LED lights used to ensure intense visual effect
- Size:
  - 992mm x 1984mm
- Replacement skins available
- Standard lead time 10 – 15 days from artwork approval



## Polyester Sleeve Light Box

- Free artwork set up
- Great for trade shows, product displays, conferences etc.
- Light weight aluminium frame clicks together for easy assembly (recommended to only display one side when light box is on)
- Available in Eco-Friendly recycled material manufactured to Global Recycled Standard 4.0 (GRS 4.0) and printed with Eco-Friendly inks
- Full colour double sided dye sublimation print on 250gsm polyester sleeve
- Bright LED lights used to ensure intense visual effect
- Size:
  - 900mm x 2300mm
- Replacement skins available
- Standard lead time 10 – 15 days from artwork approval



## Pop Up Light Box

- Free artwork set up
- Great for trade shows, presentations, displays, shop windows, shopping malls etc.
- Easy to assemble light weight foldable aluminium frame - no tools required
- Full colour single sided or double sided dye sublimation print on 150gsm polyester
- Bright LED lights used to ensure intense visual effect
- Size:
  - 1000mm x 2000mm
- Replacement skins available
- Supplied with carry bag
- Standard lead time 10 – 15 days from artwork approval



# Light Box Counters

- Free artwork set up
- Great for trade shows, exhibitions, presentations etc.
- Easy to assemble light weight aluminium frame – no tools required
- Full colour double sided dye sublimation print on 150gsm polyester
- Bright LED lights used to ensure intense visual effect
- Size:
  - 1000mm (w) x 395mm (table top) x 1030mm (h)
- Supplied with hard shell wheel bag
- Standard lead time is 10 – 15 days from artwork approval



# Exhibition Booths



Exhibition Booth A Includes:

- 1 x 3m stretch fabric display
- 1 x 1m stretch fabric display (flat, angled or curved top)
- 1 x 800mm x 500mm x 1000mm fabric covered table
- 1 x leg connector



Exhibition Booth B Includes:

- 1 x 3m stretch fabric display
- 2 x 1m stretch fabric displays (flat, angled or curved top)
- 1 x 800mm x 500mm x 1000mm fabric covered table
- 1 x 6 foot table cover
- 2 x 850mm x 2020mm pull up banners
- 2 x leg connectors



Exhibition Booth C Includes:

- 2 x 3m stretch fabric displays
- 2 x 1m stretch fabric displays (flat, angled or curved top)
- 1 x 800mm x 500mm x 1000mm fabric covered table
- 1 x 6 foot table cover
- 2 x 850mm x 2020mm pull up banners
- 3 x leg connectors

\*Other booth combinations available

# Table Covers

## Drape or Fitted Table Covers

- Free artwork set up
- Available in drape or fitted style with open or closed back and hemmed edges
- Eco-Friendly recycled material manufactured to Global Recycled Standard 4.0 (GRS 4.0) and printed with Eco-Friendly inks
- Full colour dye sublimation print on 250gsm polyester
- Entire table cover can be printed
- Standard sizes:
  - 1200mm (4 foot) table top - 1200mm x 700mm with 700mm fall (table cover total size 2600mm x 2100mm)
  - 1800mm (6 Foot) table top - 1800mm x 700mm with 700mm fall (table cover total size 3200mm x 2100mm)
  - 2400mm (8 Foot) table top - 2400mm x 700mm with 700mm fall (table cover total size 3800mm x 2100mm)
  - Custom shapes and sizes available (including Table Runners and round Table Covers)
- Table covers can be washed – we recommend hand wash or gentle cycle machine wash in cold water using a mild detergent
- Standard lead time 10 - 15 days from artwork approval for orders up to 24 table covers. Please contact us for lead times for orders of 25 or more table covers



*\*Table Runners and round Table Covers also available in custom sizes*

## Stretch Table Covers

- Free artwork set up
- Eco-Friendly recycled material manufactured to Global Recycled Standard 4.0 (GRS 4.0) and printed with Eco-Friendly inks
- Full colour dye sublimation print on 200gsm stretch polyester fabric
- Entire table cover can be printed
- Available with an open back or closed back (with or without a zip)
- Size options:
  - 1200mm (4 foot) table top - 1230mm x 750mm with 610mm fall
  - 1800mm (6 foot) table top - 1820mm x 750mm with 720mm fall
  - 2400mm (8 foot) table top - 2410mm x 750mm with 720mm fall
- Table covers can be washed – we recommend hand wash or gentle cycle machine wash in cold water using a mild detergent
- Standard lead time 10 - 15 days from artwork approval for orders up to 24 table covers. Please contact us for lead times for orders of 25 or more table covers



# Inflatables

- Free artwork set up
- Full colour dye sublimation print
- Supplied with electric pump or air blower for inflation, ropes and pegs for installation and repair patches
- Heavy duty and standard options available for the Arch and Pillar
- Heavy duty options are plugged after inflation and stay inflated for 2-5 days without top up air required
- Standard options require constant connection to electric air blower
- Please contact us for lead times

## Inflatable Arch

- Heavy duty and standard Arch size options:
  - 3000mm x 2850mm
  - 5000mm x 3350mm
  - 7000mm x 5000mm

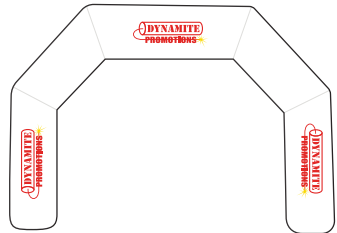

Heavy Duty & Standard Options Available

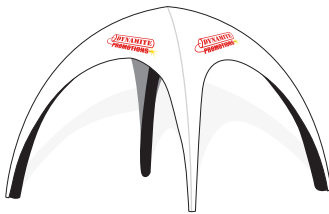

Air tent walls also available  
Air tent available as heavy duty option only

## Inflatable Tent

- Heavy duty Tent size options:
  - 10 foot: 2400mm high x 3000mm wide
  - 13 foot: 3100mm high x 4000mm wide
  - 16 foot: 3650mm high x 5000mm wide
  - 20 foot: 4400mm high x 6000mm wide

## Inflatable Banner

- Heavy duty Banner size options:
  - 6 metre
  - 8 metre
  - 10 metre

## Inflatable Pillar

- Standard Pillar size options:
  - 450mm x 2000mm
  - 670mm x 3000mm
- Heavy duty Pillar size options:
  - 400mm x 2500mm
  - 670mm x 3000mm



Heavy duty option only  
available for banner



Heavy duty & standard options available  
for pillar

# Custom Inflatables

- Free artwork set up
- Full colour dye sublimation print
- Single layer construction (120gsm) with heavy duty D-Rings
- Supplied with electric blower or inflation and ropes and pegs for installation
- Inflates in 1-2 minutes
- Constant connection to electric blower required to keep inflated
- Any size or shape available
- Please contact us for lead times



# Paper Products Range

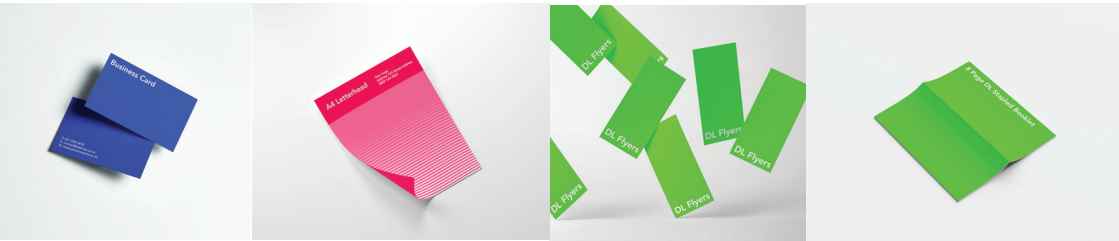

Printed locally by our Print Partner in Auckland

## Business Cards

**Stock:** Standard 300gsm, Premium 350gsm, Premium Laminated 350gsm  
**Size:** 90mm x 55mm  
**Print:** Single or Double Sided

## Flyers

**Stock:** 150gsm, 200gsm, 300gsm  
**Size:** A6, DL, A5  
**Print:** Single or Double Sided

## Brochures

**Stock:** 200gsm  
**Size:** A4 folded to DL or A5  
**Print:** Single or Double Sided

## Postcards

**Stock:** 350GSM  
**Size:** A6  
**Print:** Double Sided

## Letterhead

**Stock:** 100GSM  
**Size:** A4  
**Print:** Single or Double Sided

## Posters

**Stock:** 200gsm  
**Size:** A4, A3, A2, A1, A0  
**Print:** Single Sided



# DYNAMITE PROMOTIONS

Level 5/ 3 Te Kehu Way, Sylvia Park,  
Mt wellington Auckland 1060  
02 2427 9322  
[www.dynamitepromotions.co.nz](http://www.dynamitepromotions.co.nz)  
[info@dynamitepromotions.co.nz](mailto:info@dynamitepromotions.co.nz)